

TECHNICAL APPLICATION DOCUMENT  
VMGO – Inclad – 09



**Description:** Rendaboard – For Direct Render Applications

**Associate Documents:** Product Specification: 02

**Index**

1. Rendaboard – Direct Applied Render Board Description
2. Cutting
3. Transporting / Conditioning
4. Board Arrangement
5. Fixing Centres
6. Board Jointing
7. Expansion Gaps
8. Health & Safety

Due to our policy of continuous development we reserve the right to change specifications without prior notice. Euroform Products Limited does not accept responsibility for any loss as a result of any company or person relying on material in this publication, or for any mistakes or misprints. Although every care is taken to ensure accuracy, this publication is a general guide and specific technical advice is recommended before proceeding with any transaction.



Version 2 – 14.08.12



## 1. Description

### Direct Applied Render Systems and Rendaboard

#### Why Rendaboard?

Rendaboard is a modern practical construction material of outstanding performance. It is non-toxic, contains no hazardous volatiles and is asbestos and formaldehyde free. Rendaboard is available in 9mm & 12mm thickness, 2400 x 1200mm. Other sizes available.

- Fully External/Internal
- Pull Out Tests Available
- Resistant to attack against vermin
- Not -Toxic Under Fire
- Fully External
- Rot & Impact resistant
- Good Acoustic Performance
- Economical
- Recognised Brand
- Suitable for Lightweight Steel/Timber Frame Systems
- Can be Screw fixed

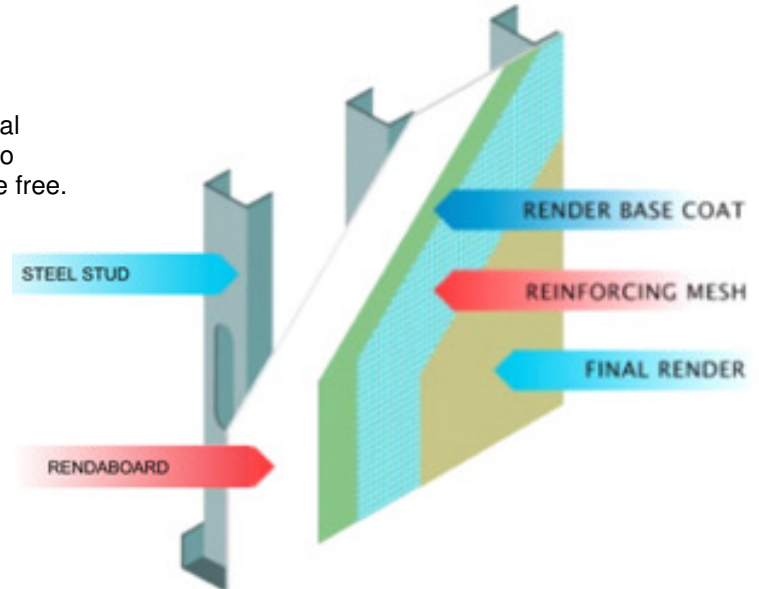

\*Drawing for general guide only, check with coating manufacturer and designer for full construction /application details.

**Rendaboard** is suitable for a wide range of applications and is a major move forward in building board technology to meet increasingly stringent building regulations and demands for ever higher standards of durability, safety and economy.

[Check with your coating manufacturer for suitability or ring us for advice on 01925 860999.](#)

## 2. Cutting

### MACHINING

Rendaboard is machined and processed using tungsten carbide tipped blades are used at all times.

### SAWING

Equipment

- Cross cut hand saws for thicknesses up to 12mm.
- Jigsaw for thicknesses up to 12mm and small work.
- Portable circular saw.
- Fixed saw for dimensioning (vertical or horizontal).

Type of blade.

- Alternative or trapezoidal teeth.
- Chart shows number of revolutions and number of teeth (Z).

<b>Diameter mm</b>	<b>250</b>	<b>300</b>	<b>350</b>	<b>400</b>
Panel thickness up to 12mm	Z=48	Z=60	Z=72	Z=72
Panel thickness exceeding 12mm	Z=36	Z=48	Z=54	Z=60
Number of revolutions rpm	3000/4500	3000	3000	3000/1500

### MILLING

Common machines with carbide-tipped tools. The higher the rpm, the better the milled edge.

### 3. Transporting / Conditioning

#### Transport

Rendaboard boards are usually delivered secured in plastic bound, edge protected pallets. When loose boards are transported they must be laid flat and fully protected with a waterproof sheet. When manually moving Rendaboard it must be carried in a vertical position.

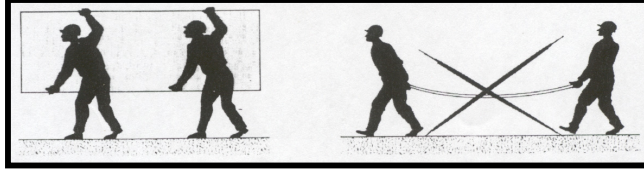

#### Storage

Rendaboard should be stored flat on levelled supports at 800mm centres. It must never be stored on edge or upright. If outside, a protective plastic sheet must be secured to protect from weather.

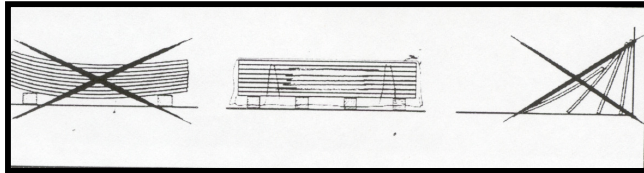

#### Conditioning

Rendaboard has an ex-works moisture content of 9% + / - 3% and is in equilibrium when the temperature is 20°C with a relative air humidity of 50-60%. Rendaboard adapts to the ambient humidity level, therefore to adjust to its working conditions it should be allowed to acclimatise for 24-48 hours prior to fixing. Rendaboard should be kept as dry as possible before applying render ensuring that the moisture content complies with the render manufacturers recommendations before application.

#### Product Hazard Information - Health & Safety Statement

FIRE: Class O  
TOXIC GAS: Nil  
HEALTH: **Skin contact** - classified as non-aggressive dust.  
**Eye contact** - Normal Treatment for removing foreign bodies from eyes.  
**Inhalation** - Process is non-aggressive, but protection recommended when processing material.

COMPOSITION: Inorganic Materials  
Wood Fibre  
Water  
Glass Fibre  
Non-Woven Cloths

For further information in relation to COSHH please contact our technical services 01925 860999.

## 4. Board Arrangement

Diagram A:  
Vertical Board Arrangement

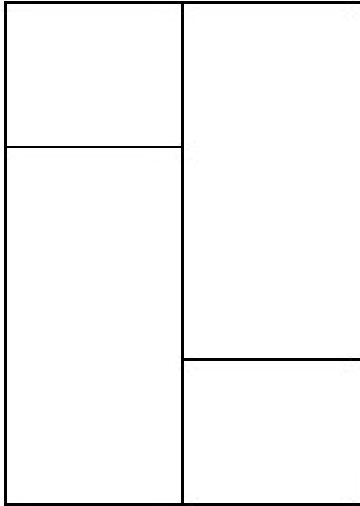
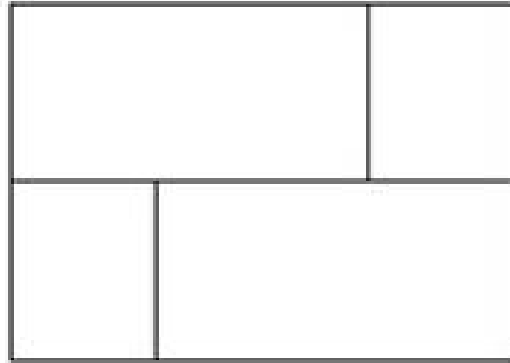

Diagram B:  
Horizontal Board Arrangement



When fixing board to metal frame, use Brick Bond arrangement as shown.

**Note**

- Do not use 4 way joints.
- Minimum board width should not be less than 100mm.

Diagram C:  
Typical Steel Frame with Window Aperture

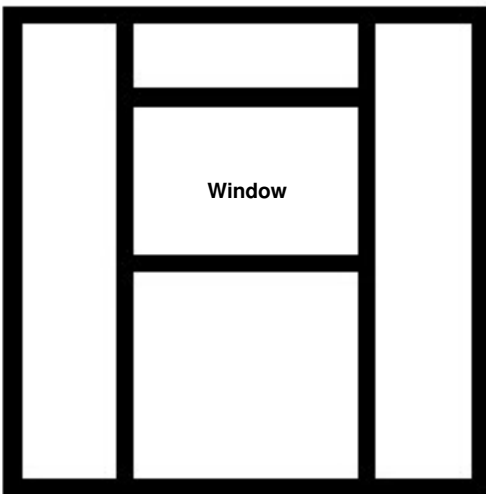
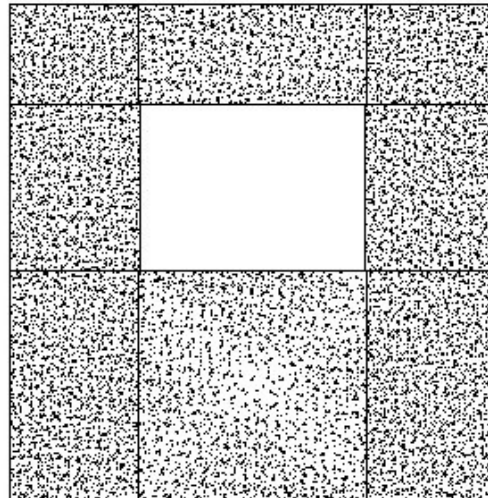

Diagram D:  
Typical Steel Frame with Rendaboard Arrangement



Boards to be flush with the web of studs and noggins around a typical window aperture.

## 5. Fixing Centres

Diagram E: Fixing Centres and Fixings

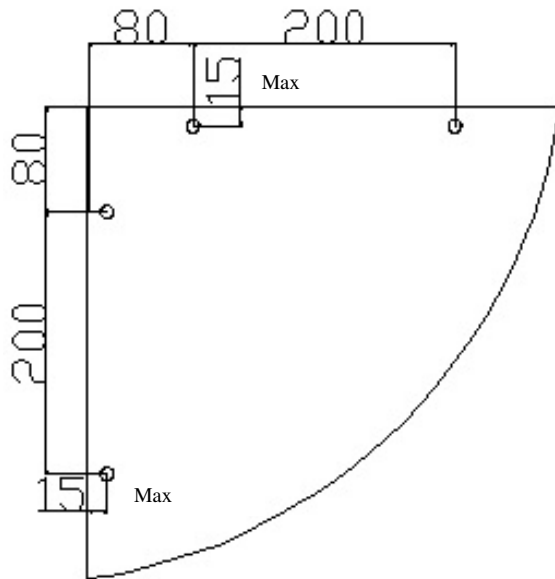

Screw fixings should be self-drilling and self countersinking screws in stainless steel. Screw diameter should be from 3.5mm to 4.2mm length should be 2.5 to 3 times the thickness of the panel.

Fixings at the perimeter of the panel should be a nominal 200mm and on intermediate supports nominal 300mm centres.

Distance in from the edges should be a maximum of 15mm.

For application of direct applied render all edges should coincide with support structure as detailed.

Centres can be adjusted to avoid clashes with frame fixings underneath.

Diagram F: Minimum Board Width

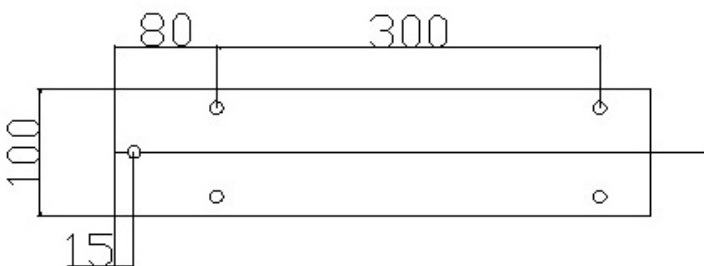

As shown on diagram F, minimum board width is 100mm, fixing centres as shown.

## 6. Board Jointing

Diagram G: Horizontal Board Jointing

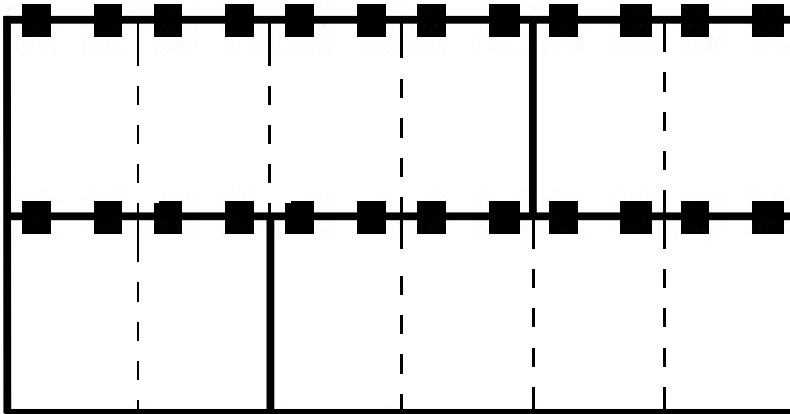
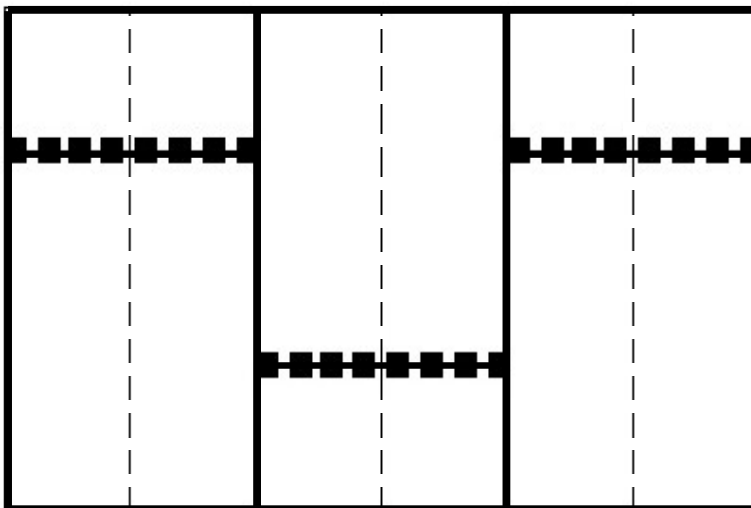

Diagram H: Vertical Board Jointing



■ ■ ■ ■ = represents backing strip for extra support which is required by direct applied render systems only

----- = represents Hidden Stud

In Diagram G and H, boards are supported at 600mm centres by studs.

The extra support can be in the form of noggins or a backing strip as shown in Diagram I.

Diagram I: Board Jointing

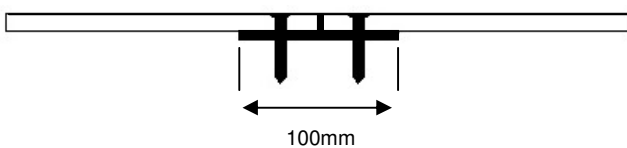

Backing strip used for extra support clamped in position before fixing.

## 7. Expansion Gaps

Diagram J: Layout

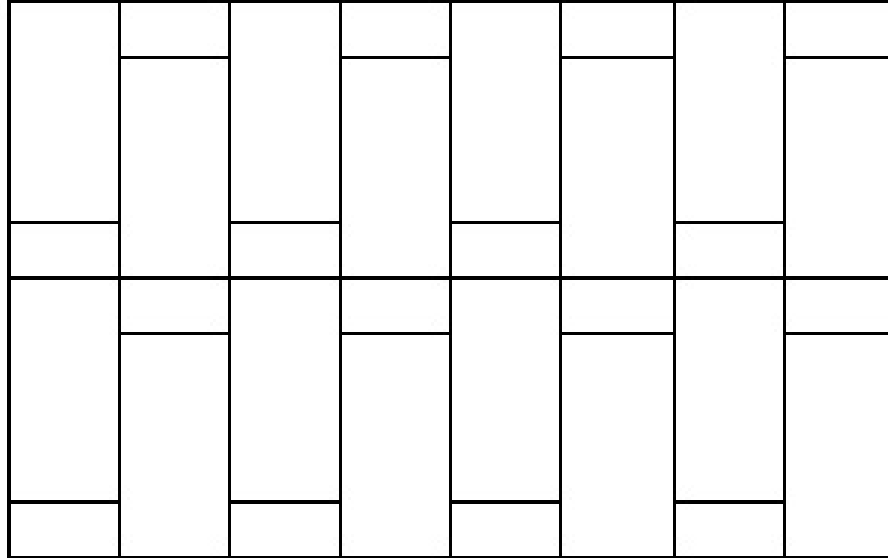

Within a single frame assembly up to 12000 x 4500 max, gaps between boards should be 4mm.

Where 2 frame assemblies meet, expansion gaps to be 10mm.

Conditions for fixing frames over this size must be considered on a project by project basis and Euroform must be consulted.

### **Additional Information**

Support structure for rendaboard 9mm and 12mm should be at a maximum of 600mm centres, based on board size of 2440 x 1220 there should be a 4mm gap between boards on all edges. Board joints should be treated in accordance with the render manufacturers requirement.



## **8. Health & Safety**

### **1. PRODUCT INFORMATION**

Trade Name **Rendaboard**

Generic Name: Fire Retardant Construction Board

Supplier: Euroform Products Limited

---

### **2. PRODUCT INGREDIENTS**

Manufactured from:

Inorganic Materials      Water              Wood Fibre      Glass Fibre      Non-Woven Cloths

---

### **3. HAZARDS IDENTIFICATION**

The product is not classified as hazardous

---

### **4. FIRST AID MEASURES**

The product as supplied does not present any problem in terms of eye contact or skin contact, ingestion or Inhalation

---

### **5. FIRE FIGHTING MEASURES**

Material is not combustible. Select extinguishing agent appropriate to other materials involved.

---

### **6. ACCIDENTAL RELEASE MEASURES**

Collect mechanically

---

### **7. HANDLING AND STORAGE**

No special handling measures necessary.  
Store in ambient warehouse conditions.

---

### **8. EXPOSURE CONTROLS / PERSONAL PROTECTION**

No special measures necessary.  
Personal protective equipment not required.

---

### **9. PHYSICAL AND CHEMICAL PROPERTIES**

Appearance:	Solid white board
Odour:	None
Melting point:	Not Applicable
Boiling point:	Not Applicable
Flash point:	Not Applicable
Reaction with water:	None
Ph:	Not Applicable

---

### **10. STABILITY AND REACTIVITY**

Stable  
Conditions to avoid – Not Known  
Materials to avoid – Not Known

## 11. TOXICOLOGICAL INFORMATION

Product is not classified as hazardous.

Note: In respect of any dust which may be associated with the product, Magnesium Oxide, (as Mg), Occupational Exposure Limit:-  
Total inhaled dust 10mg/m<sup>3</sup> (8 hour TWA reference period)  
Fume & respirable dust 4mg/m<sup>3</sup> (8 hour TWA reference period)  
10mg/m<sup>3</sup> (15 minute reference period)

---

## 12. ECOLOGICAL INFORMATION

No adverse effects anticipated.

---

## 13. DISPOSAL CONSIDERATIONS

Dispose via an authorised waste disposal contractor to an approved waste disposal site, observing all relevant regulations/

---

## 14. TRANSPORT INFORMATION

The product is not classified as hazardous for transport.

---

## 15. REGULATORY INFORMATION

Product is not classified as hazardous.

This safety data sheet is issued in compliance with the general requirement of Section 6 of The Health & Safety at Work etc, Act of 1974, for provision of information to make the user aware of any risks to Health & Safety of a product.

UK Laws and Regulations relevant to the preparation of this safety data sheet include:-  
Health and Safety at Work etc, Act 1974  
Control of Substances Hazardous to Health Regulations, 1999, (COSHH)  
CHIP 3 Regulations 2002, (See section 16)

---

## 16. OTHER INFORMATION

Data used for compilation of the information given in this data sheet include:-  
The Chemicals (Hazard Information and Packaging for Supply) Regulations 2002 (CHIP 3)  
The Approved Code Of Practice, Compilation of safety data sheets, (Third Edition)  
Occupational Exposure Limits 2002 (EH40/2002)

The information given is accurate to the best of the knowledge of Euroform Products Ltd, and is based on information, which the company considers to be reliable.  
Further Health, safety and environmental information may be obtained from the company.



Certificate Number 3961



Due to our policy of continuous development we reserve the right to change specifications without prior notice. Euroform Products Limited does not accept responsibility for any loss as a result of any company or person relying on material in this publication, or for any mistakes or misprints. Although every care is taken to ensure accuracy, this publication is a general guide and specific technical advice is recommended before proceeding with any transaction.